



Product Name: 5G NR / 4G LTE Terminal Antenna

Part Number: TA-18W-A-L01

Features:

- Support 5G NR/ 4G LTE 617-960MHz, 1710-2690MHz, 3300-4000MHz , 5150-5850MHz
- Support Japan Band 1420-1561MHz
- Robust, IP67 Water-proof Housing
- Optional Pole/ Wall-Mount Brackets Available to order
- RoHS & REACH Compliant

Applications:

- Gateway/ Router Application
- Machine to Machine Communication

5G NR / 4G LTE Terminal Antenna

MODEL: TA-18W-A-L01

Rev.A

I. Specifications:

Items	Specifications									
Application Bands	5G NR Band 71	LTE 700	GSM 850/900	Japan Band 74 ~ 76	DCS	PCS	UMTS1	LTE 2600	5G NR Band	5G NR Band
Frequencies (MHz)	617 ~ 698	698 ~ 824	824 ~ 960	1420 ~ 1561	1710 ~ 1880	1850 ~ 1990	1920 ~ 2170	2300 ~ 2690	3300 ~ 4000	5150 ~ 5850
Efficiency (%)	54.39	41.53	43.91	75.16	47.52	43.20	51.36	42.77	38.98	30.74
Average Gain (dBi)	-2.65	-3.82	-3.57	-1.24	-3.23	-3.65	-2.89	-3.69	-4.09	-5.12
Peak Gain (dBi)	2.06	2.94	5.02	4.60	3.07	1.67	1.53	2.88	3.06	2.43
V.S.W.R	< 6	< 3.5		< 2.3	< 4.5		< 8.7	< 8.7	< 6	< 8.7
Return Loss (dB)	< -3	< -5		< -8	< -4		< -2	< -2	< -3	< -2
Impedance (Ω)	50									
Test Conditions	Free Space									
Polarization	Linear									
Connector	N-Type									

© Unictron Technologies Corp.
All specifications subject to change without notice.

Mechanical	
Dimension (mm)	φ23.50(D) x 208.10(L)
Waterproof Resistant	IP67
Environmental Conditions	
Operation Temperature	-40 ~ +85 °C
Storage Temperature	-40 ~ +85 °C
Humidity	95% non-condensing

II. Antenna Technical Parameters:

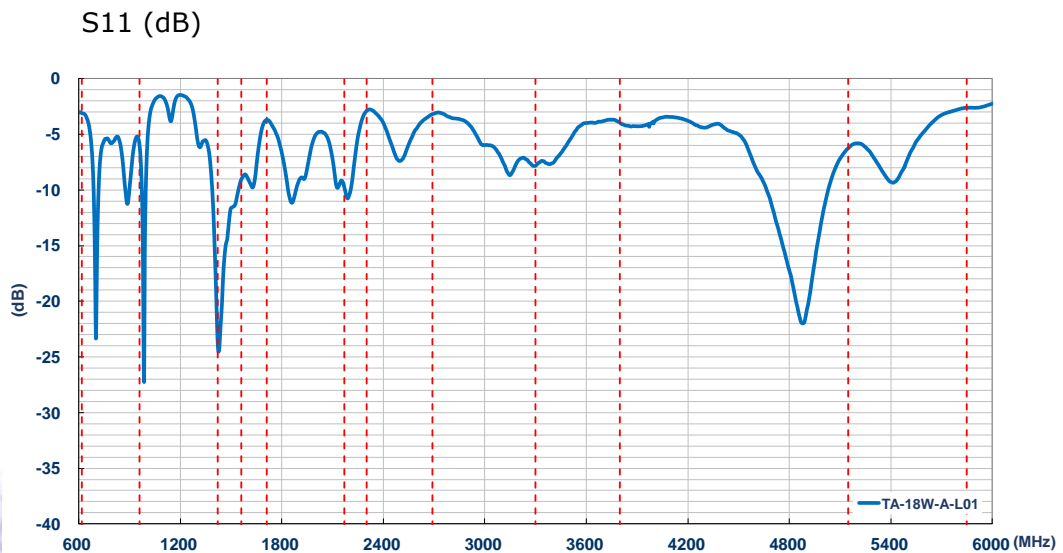

Efficiency (%)

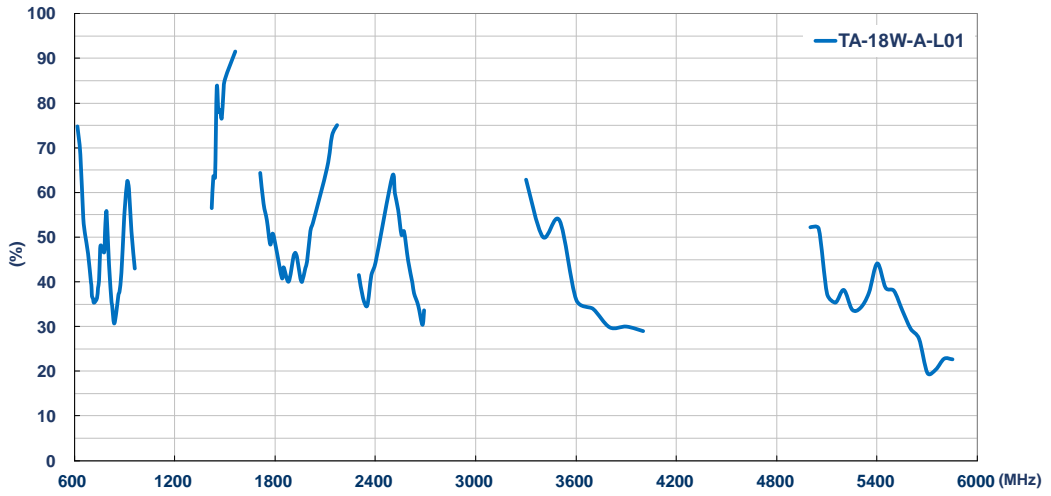

Average Gain (dBi)

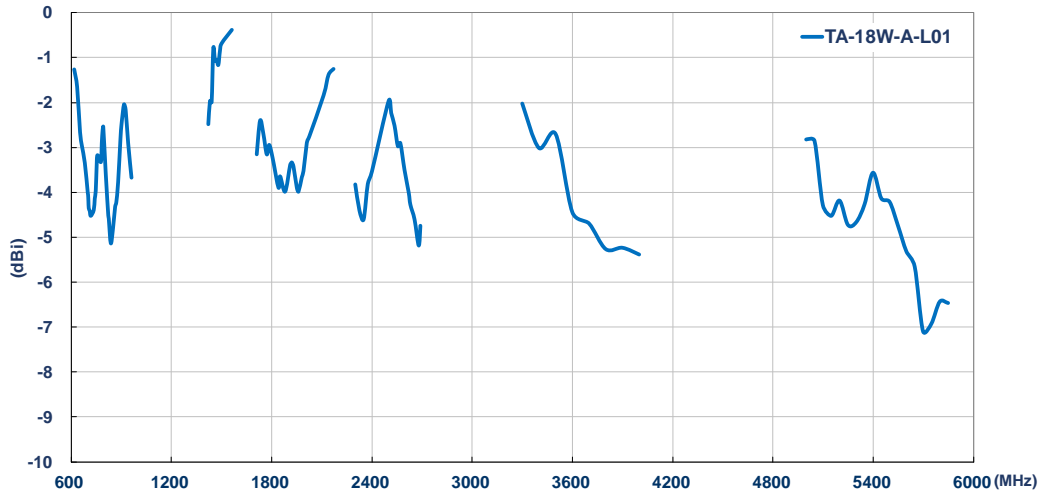

Peak Gain (dBi)

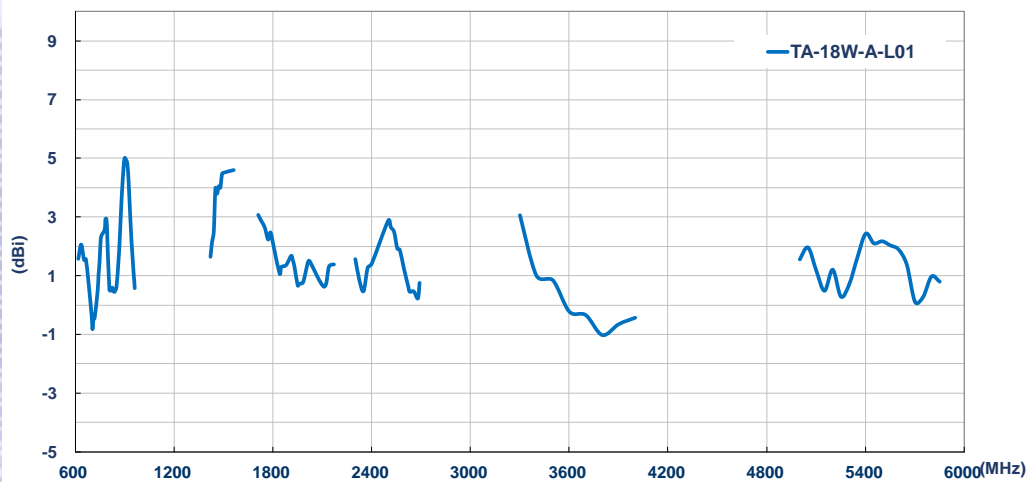

© Unictron Technologies Corp.
All specifications subject to change without notice.

III. Antenna Radiation Pattern Measurement:

The antenna radiation patterns are measured in 3D Anechoic Chamber. The measurement setup is as show below,

Free Space



© Unictron Technologies Corp. All specifications subject to change without notice.

IV. 2D Radiation Pattern:

X-Y Plane

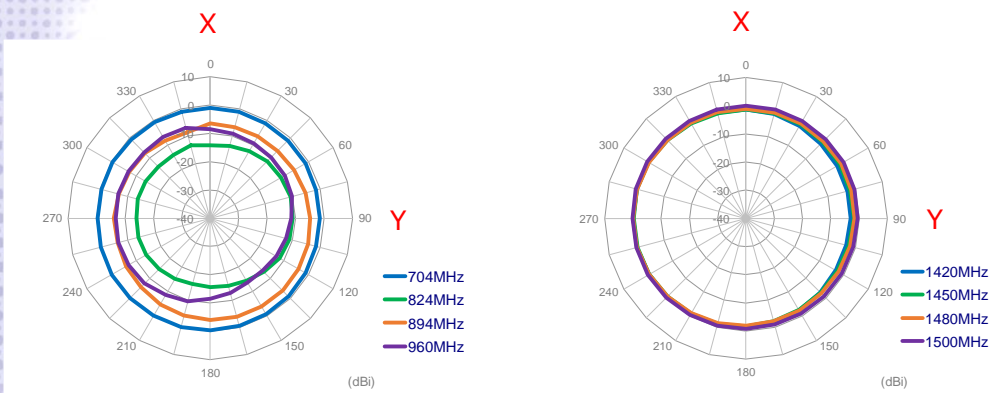

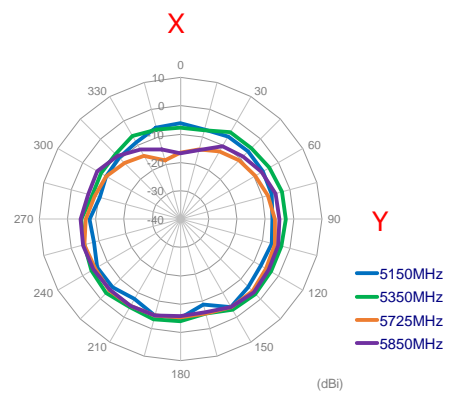
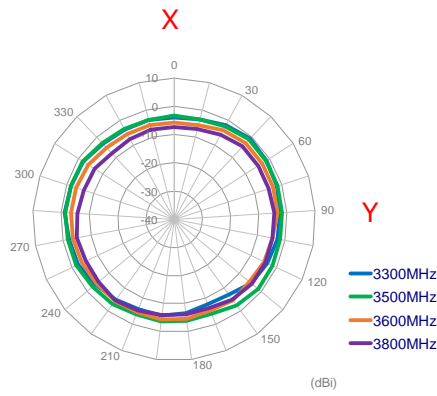
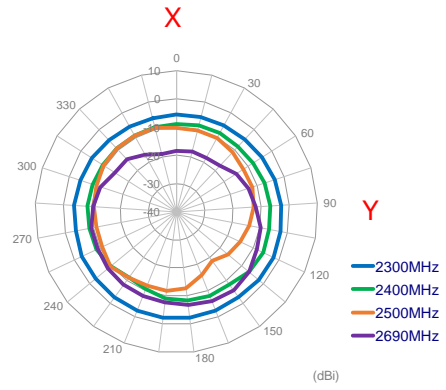
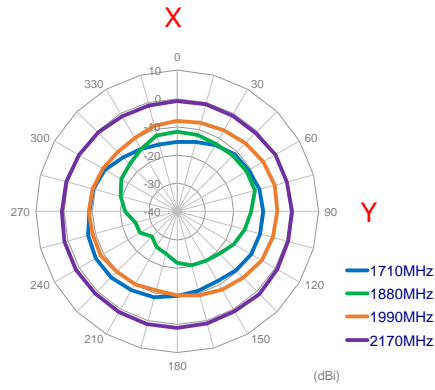

X-Z Plane

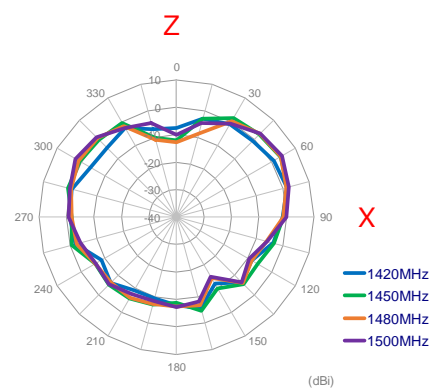
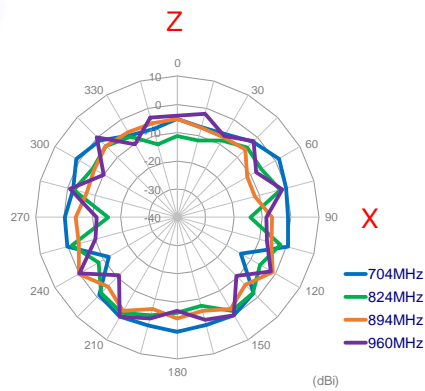

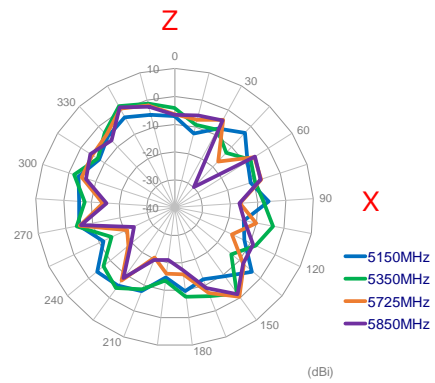
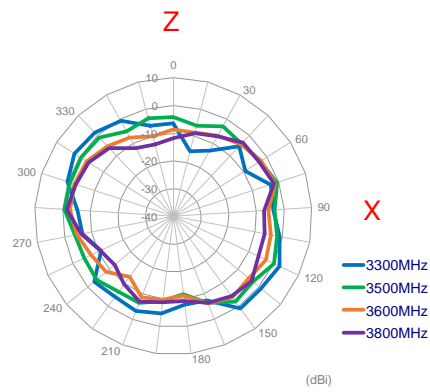
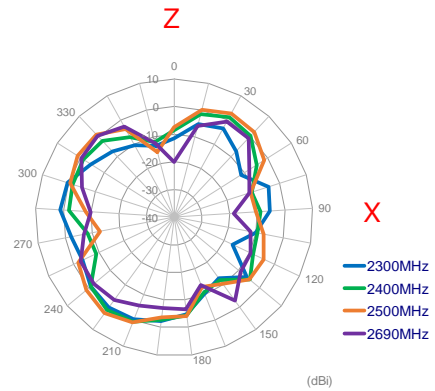
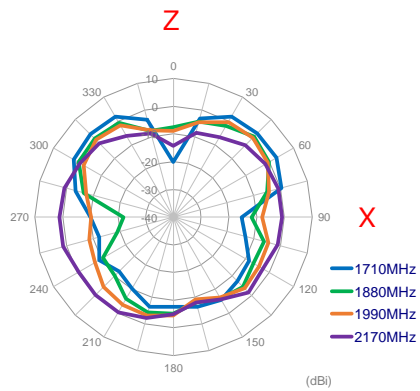

Y-Z Plane

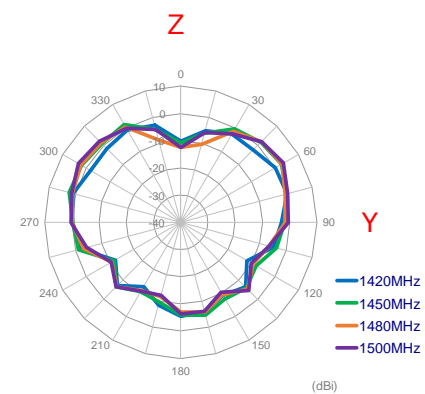
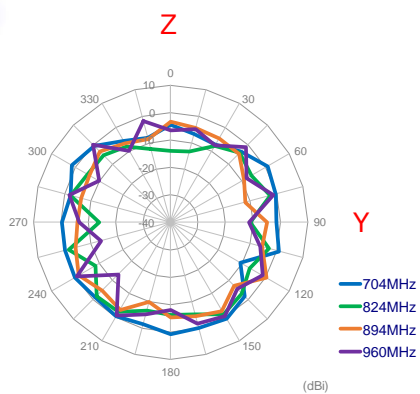

© Unictron Technologies Corp.
All specifications subject to change without notice.

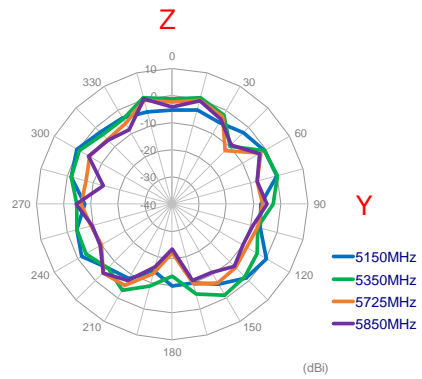
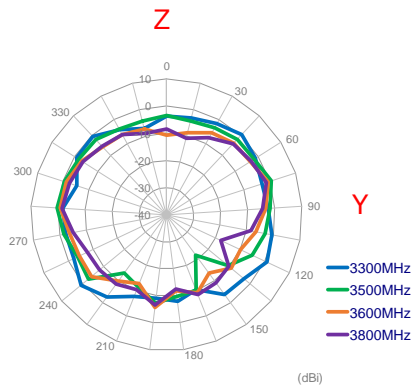
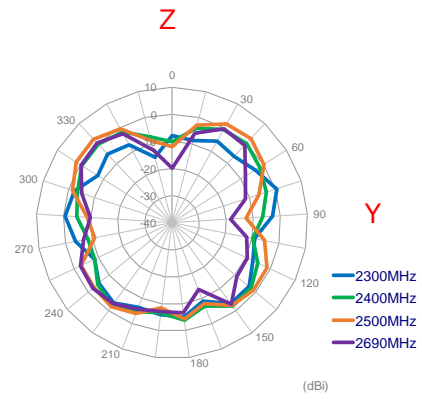
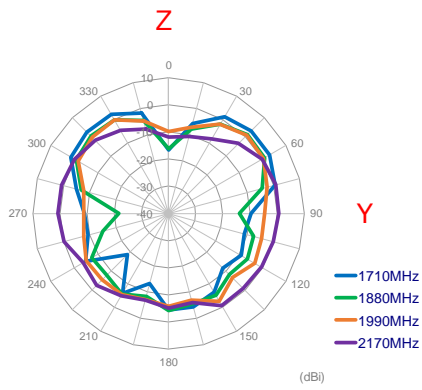

© Unictron Technologies Corp.
All specifications subject to change without notice.

V. 3D Radiation Pattern:

617MHz

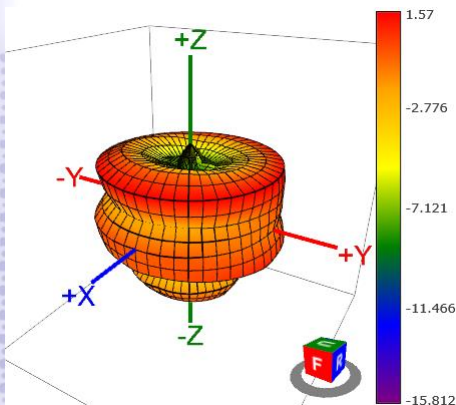

960MHz

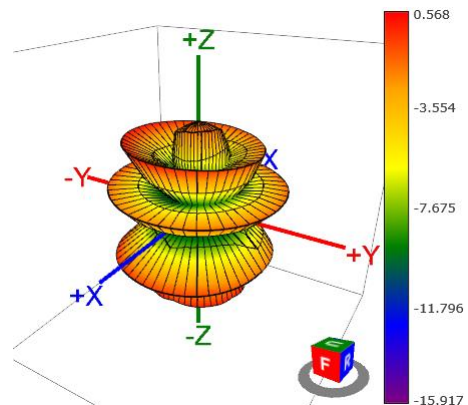

1420MHz

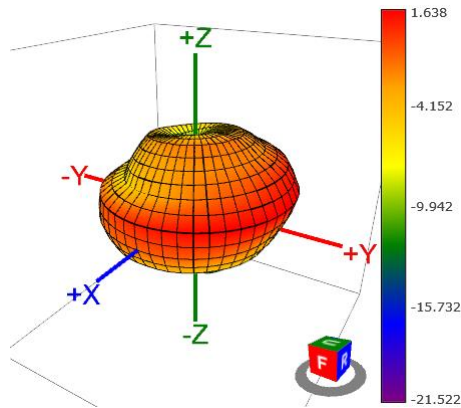

1500MHz

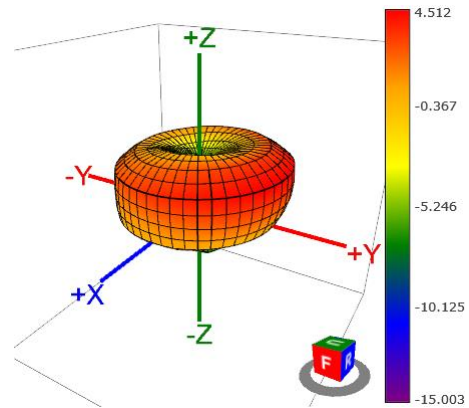

1710MHz

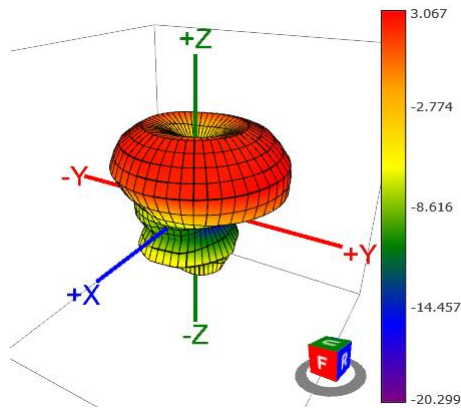

2170MHz

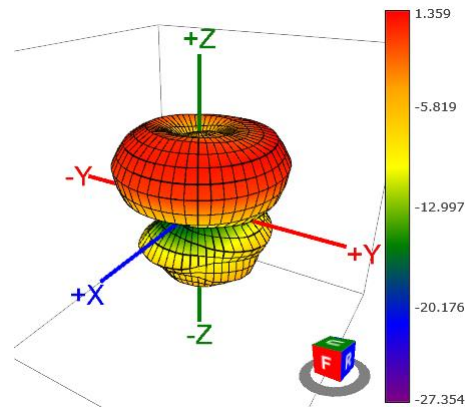

2300MHz

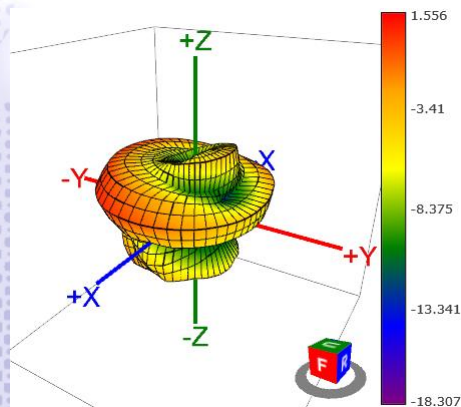

2690MHz

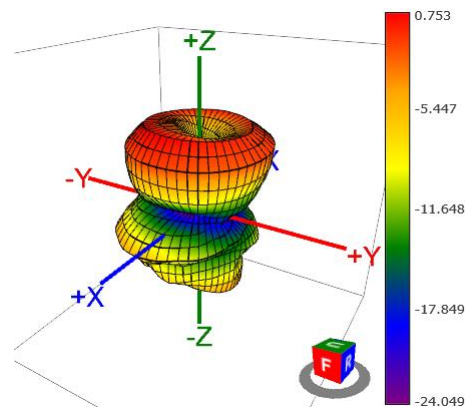

© Unictron Technologies Corp.
All specifications subject to change without notice.

3300MHz

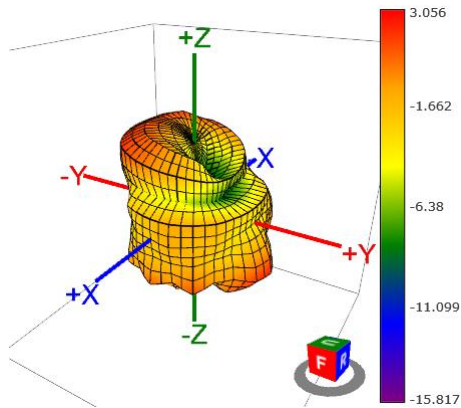

3800MHz

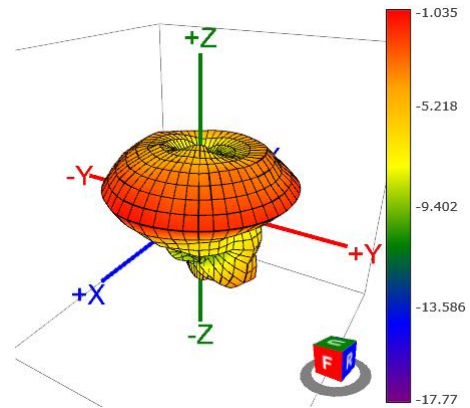

5150MHz

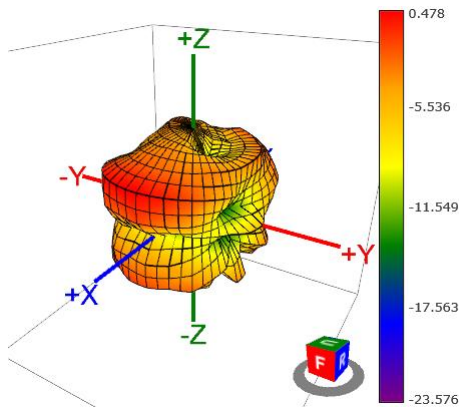

5725MHz

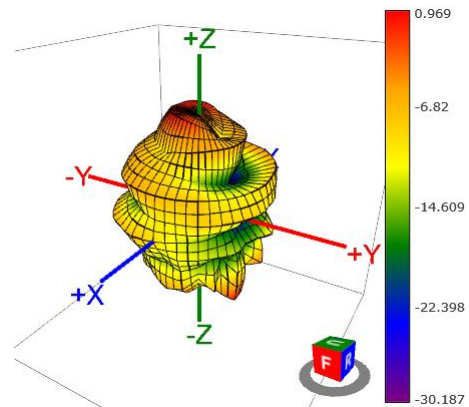

5850MHz

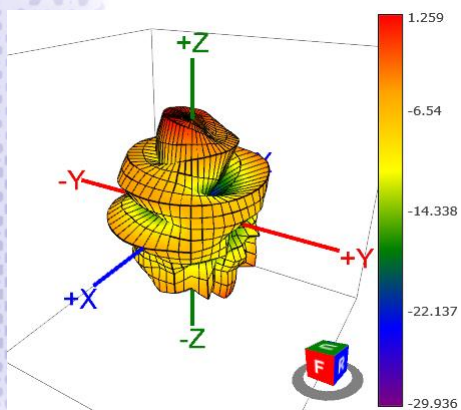

© Unictron Technologies Corp.
All specifications subject to change without notice.

VI. Mechanical Drawing (Unit:mm):

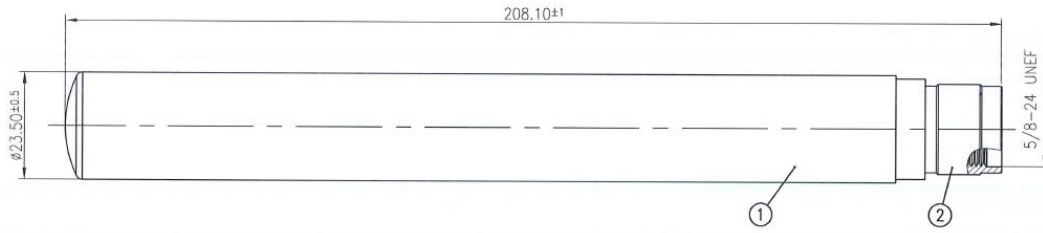

Notes:

1. All material must be RoHS compliant.
2. IP Code: IP67.

2	N type Connector	Brass	Ni Plated	1
1	Housing	ASA	White	1
No	NAME	MATERIAL	FINISH	Q'TY

© Unictron Technologies Corp.
All specifications subject to change without notice.