



Product Name: ISM915 Terminal Antenna

Part Number: TA-26B-A-S01

Features:

- Support ISM 915MHz Band
- Diameter:10mm, Length:160mm
- SMA Male Connector
- RoHS & REACH Compliant

Applications:

- Machine to Machine Communication & IOT Application
- Fleet Management & Telematics
- Vehicle Tracking

ISM915 Terminal Antenna

MODEL: TA-26B-A-S01

Rev.A

I. Specifications:

Items	915MHz		
Frequencies (MHz)	902	915	928
Efficiency (%)	93.97	98.40	89.13
Average Gain (dBi)	-0.27	-0.07	-0.50
Peak Gain (dBi)	3.24	3.75	3.44
V.S.W.R	< 2 : 1		
Return Loss (dB)	< -10		
Test Condition	Free Space		
Impedance (Ω)	50		
Polarization	Linear		
Mechanical			
Dimension (mm)	160(L) x 10(D)		
Color	Black		
Connector	SMA (Male)		
Environmental Conditions			
Operating Temperature (°C)	-40~+85		
Storage Temperature (°C)	-40~+85		
Relative Humidity	95% non-condensing		

© Unictron Technologies Corp.
All specifications subject to change without notice.

II. Antenna Technical Parameters:

© Unictron Technologies Corp.
All specifications subject to change without notice.

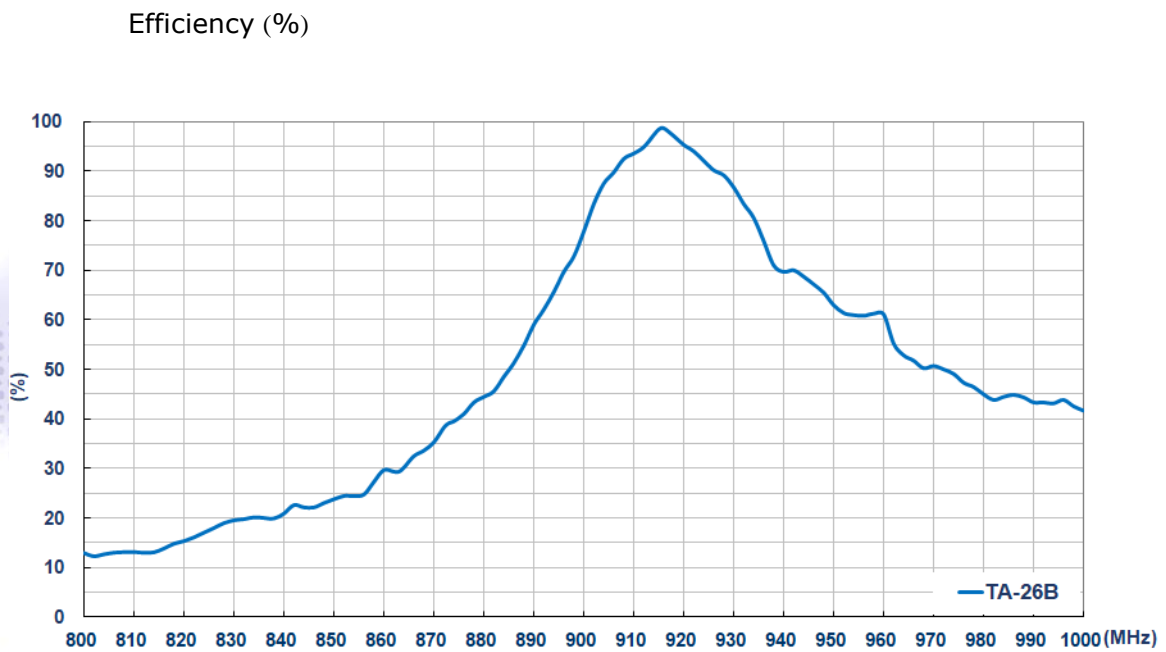
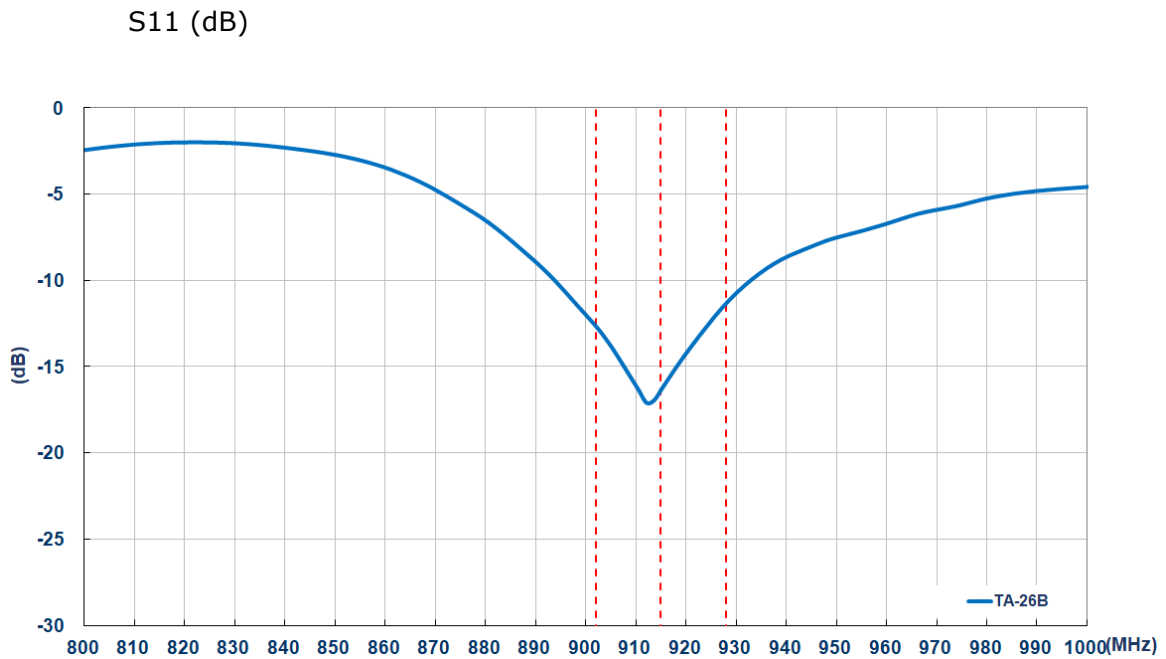

Average Gain (dBi)

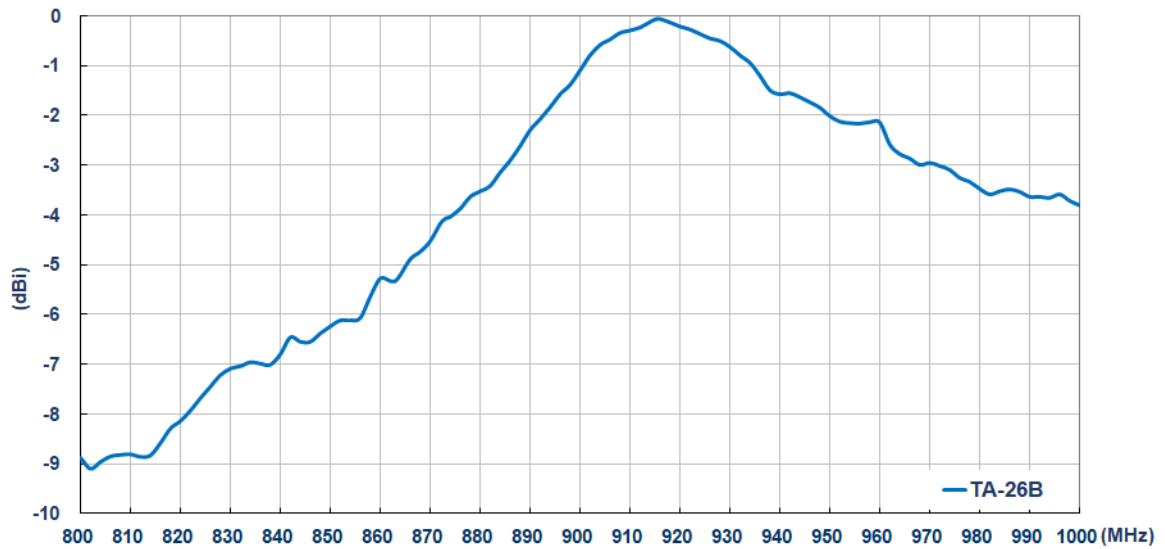

© Unictron Technologies Corp.
All specifications subject to change without notice.

Peak Gain (dBi)

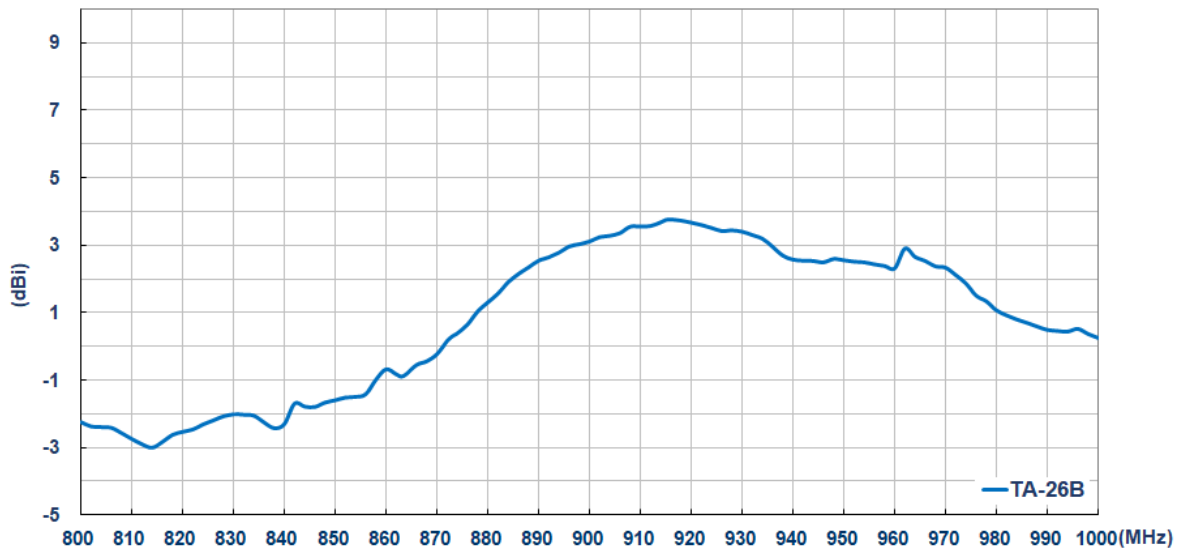

III. Antenna Radiation Pattern Measurement:

The antenna radiation patterns are measured in 3D Anechoic Chamber. The measurement setup is as show below,

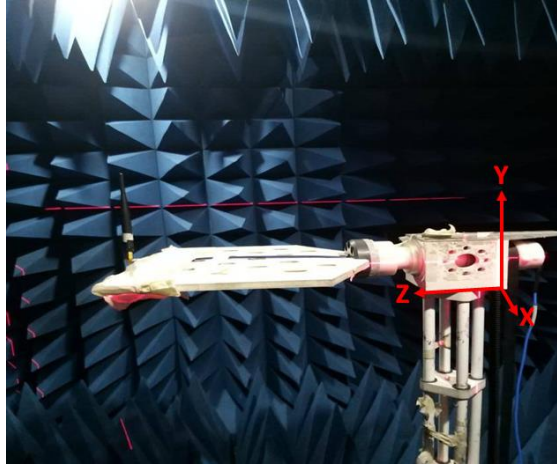

© Unictron Technologies Corp. All specifications subject to change without notice.

IV. 2D Radiation Pattern:

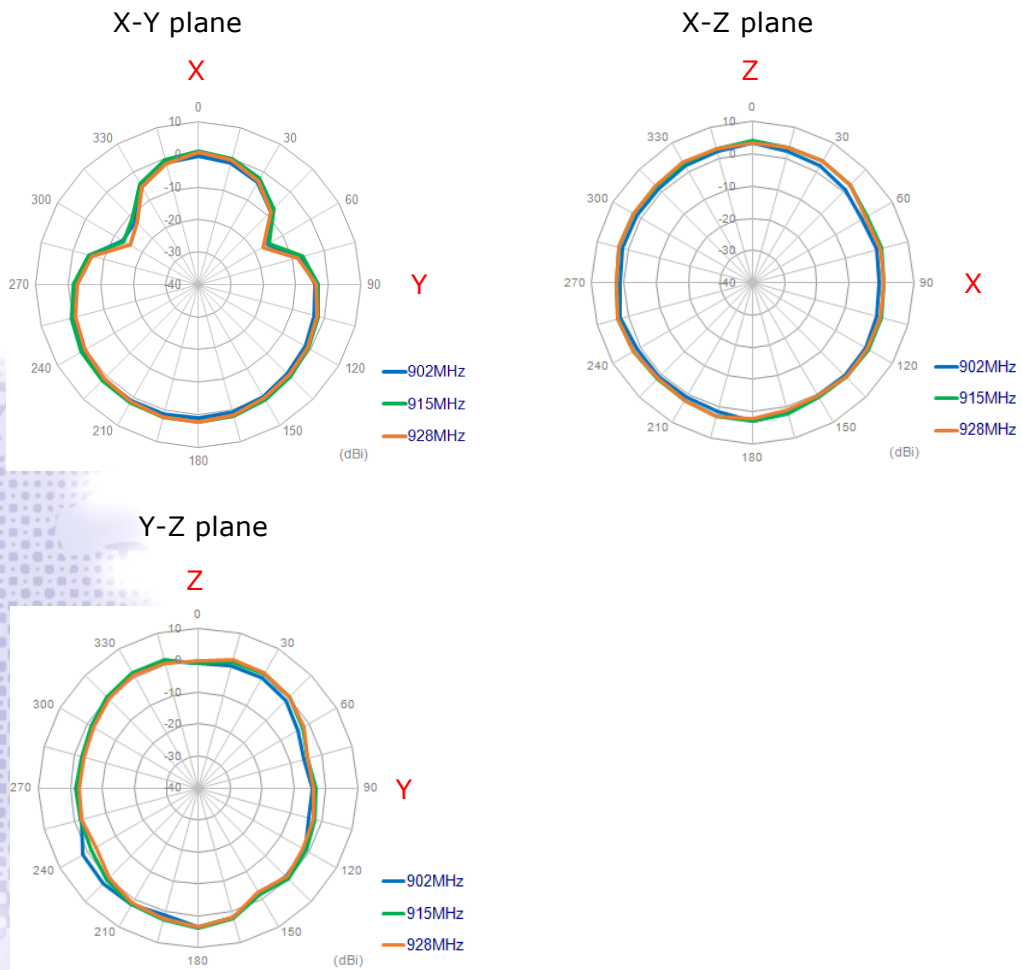

V. 3D Radiation Pattern:

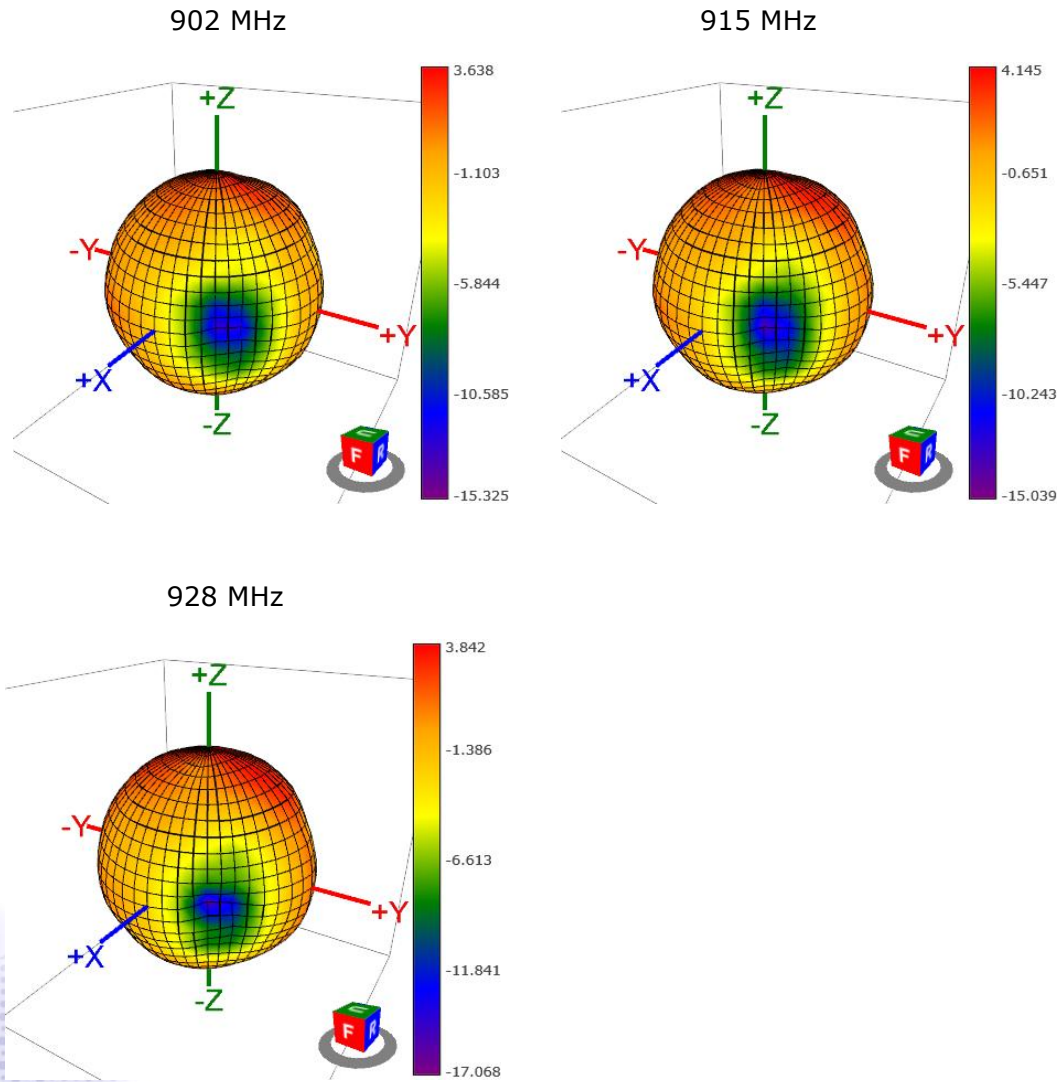

© Unictron Technologies Corp.
All specifications subject to change without notice.

VI. Mechanical Drawing (Unit:mm):

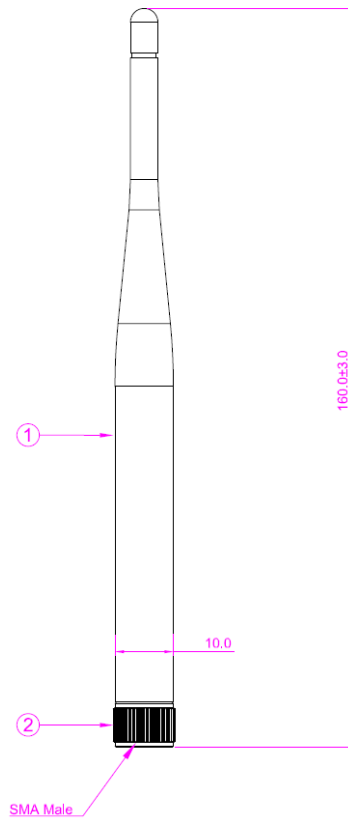

2	SMA Male	Brass	Black	1
1	Body	TPEE	Black	1
No.	Name	Material	Finish	Q'ty