



Product Name: External GNSS L1 Antenna

Part Number: EG-24W-AC-N01

Features:

- Support GPS / GLONASS L1 Bands
- Excellent Out of Band Rejection, Up to 55dB
- 27dB Active Peak Gain
- Robust Enclosure, IP67 Waterproof
- RoHS & REACH Compliant

Applications:

- Automotive Navigation
- For all GNSS applications with networking such as sensor, sonar multi-function gauge, etc.

External GNSS L1 Antenna

MODEL: EG-24W-AC-N01

Rev.A

I. Specifications:

Items	Specifications	
Passive Antenna Performance		
Application Bands	GPS	GLONASS
Frequencies (MHz)	1575.42	1602
Efficiency (%)	56.89	51.40
Average Gain (dBi)	-2.45	-2.89
Peak Gain (dBi)	0.94	0.33
V.S.W.R	< 2.5	
Return loss (dB)	< -8	
Impedance (Ω)	50	
Polarization	R.H.C.P. (Right-Handed Circular Polarization)	
Active Antenna Performance		
Application bands	GPS	GLONASS
Frequency (MHz)	1575.42 \pm 1.023	1602 \pm 5
Gain (dB)	27	27
Noise Figure (dB)	0.98	0.92
Operation Voltage (V)	3.3 ~ 5.0	
Current Consumption (mA)(typical)	9.0	
Output Impedance (Ω)	50	

© Unictron Technologies Corp.
All specifications subject to change without notice.

Out of Band Rejection			
Frequencies (MHz)	600 ~ 1300	1300 ~ 1530	1650 ~ 3000
Out of Band Rejection (dB)	55	30	30
ESD Protection	+/- 8 KV (direct discharge) +/- 15KV (air discharge)		
Mechanical Specifications			
Dimension (mm)	φ 59.30(D) x 16.00(H)		
Connector	TNC (SBJ)		
Waterproof	IP67		
Environmental Conditions			
Operation Temperature (°C)	-40 ~ +85		
Storage Temperature (°C)	-40 ~ +85		
Relative Humidity	95% non-condensing		

© Unictron Technologies Corp.
All specifications subject to change without notice.

II. Passive Electrical Properties:

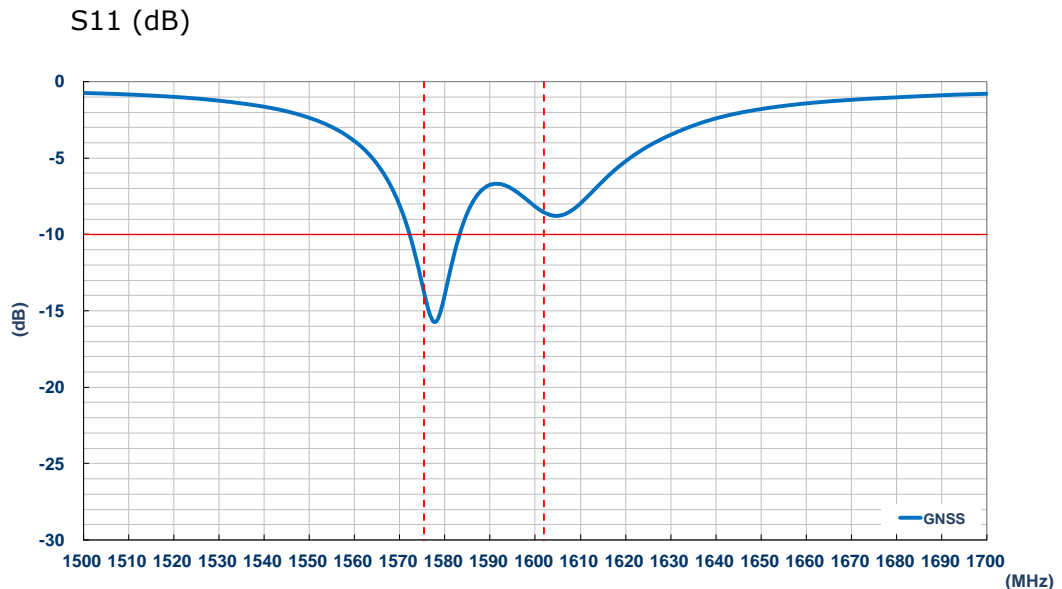

Efficiency (%)

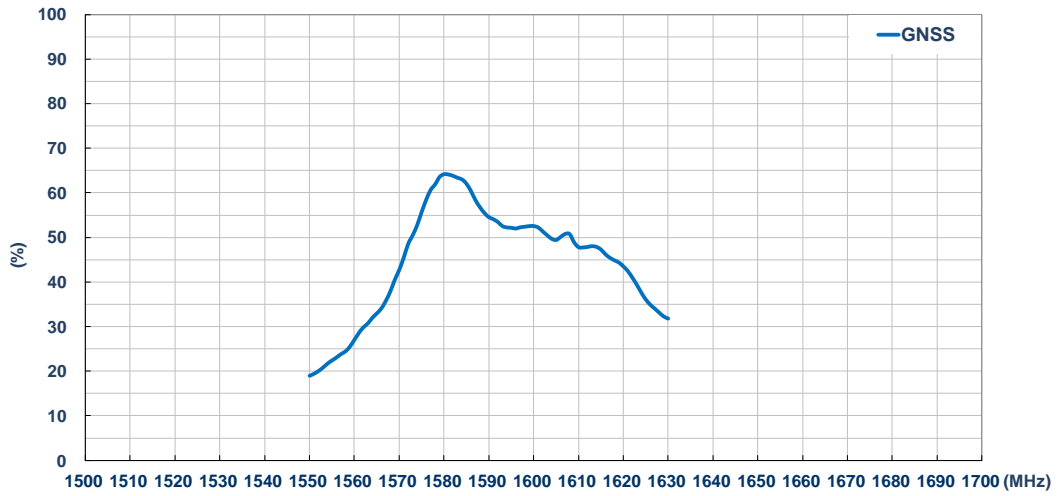

Average Gain (dBi)

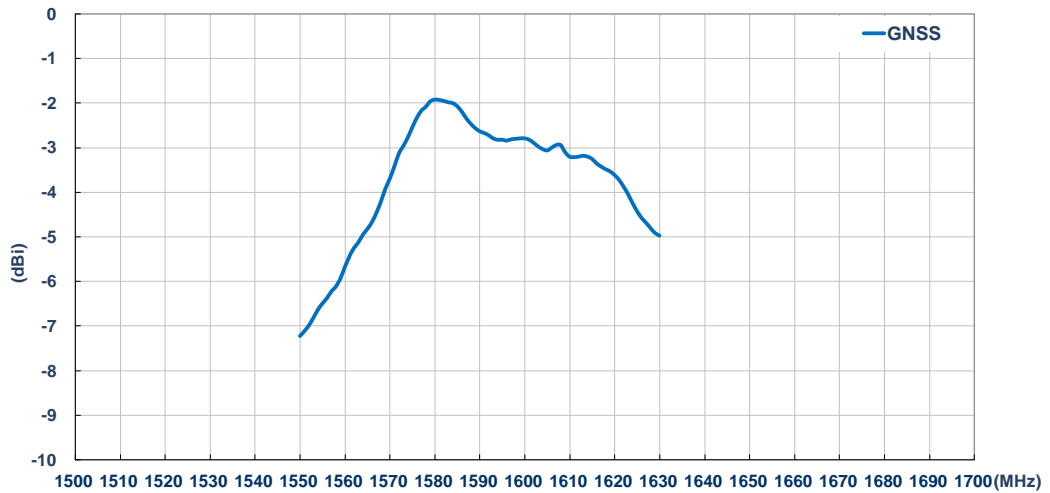

Peak Gain (dBi)

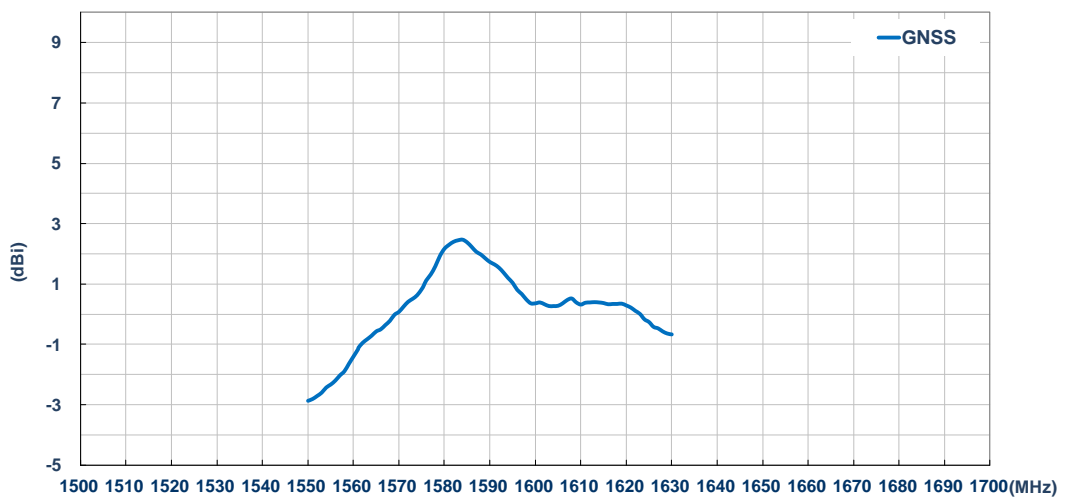

III. Active Electrical Properties:

© Unictron Technologies Corp.
All specifications subject to change without notice.

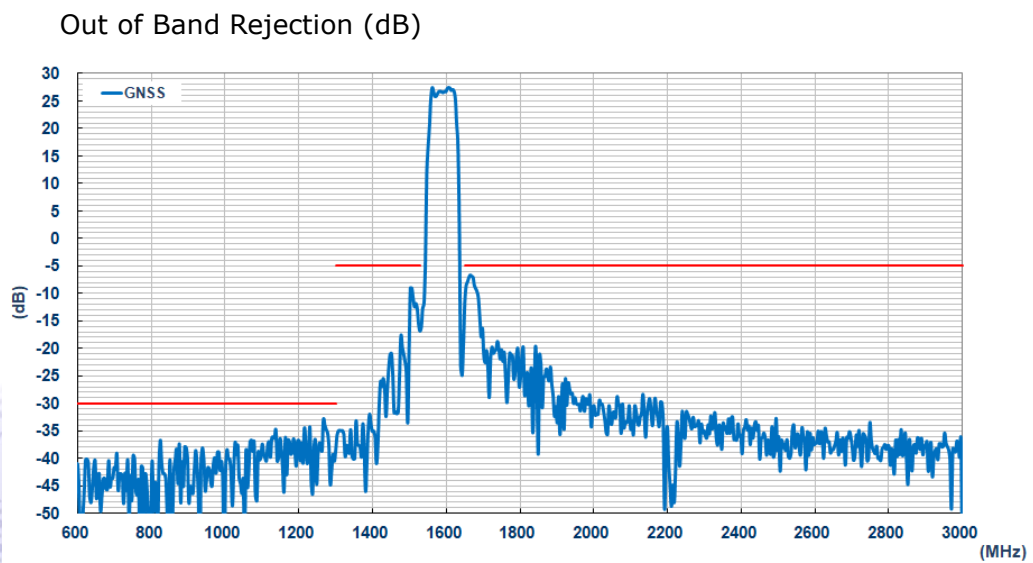
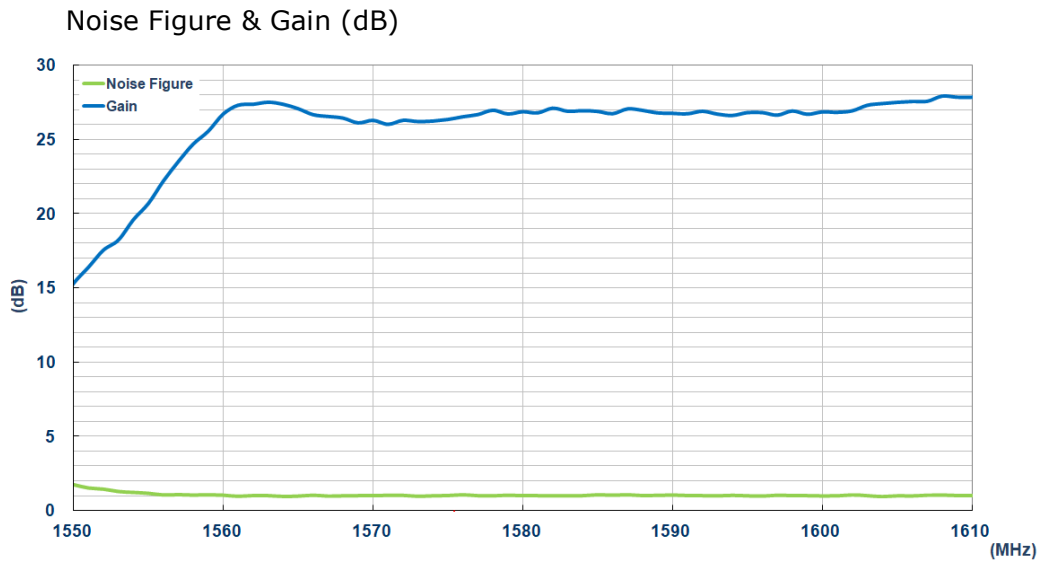

IV. Antenna Radiation Pattern Measurement:

The antenna radiation patterns are measured in 3D Anechoic Chamber. The measurement setup is as show below,

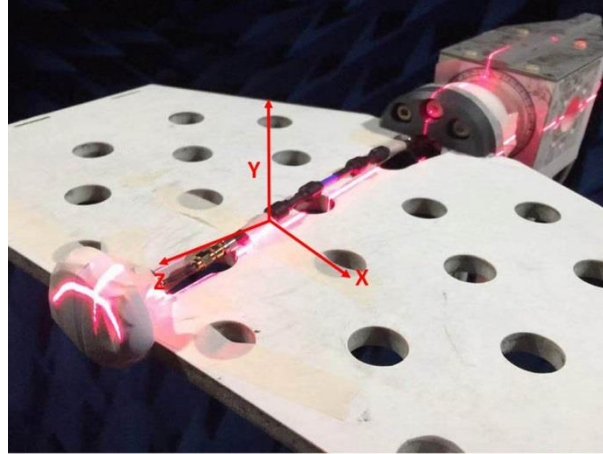

© Unictron Technologies Corp.
All specifications subject to change without notice.

A) 2D Radiation Pattern:

X-Y Plane

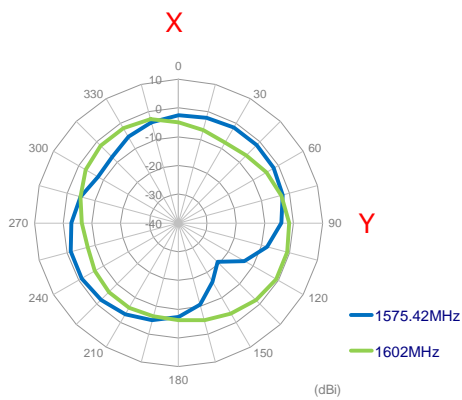

X-Z Plane

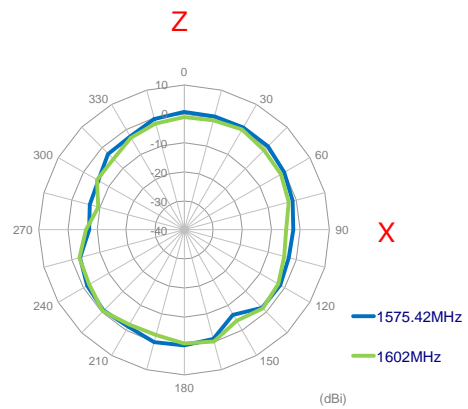

Y-Z Plane

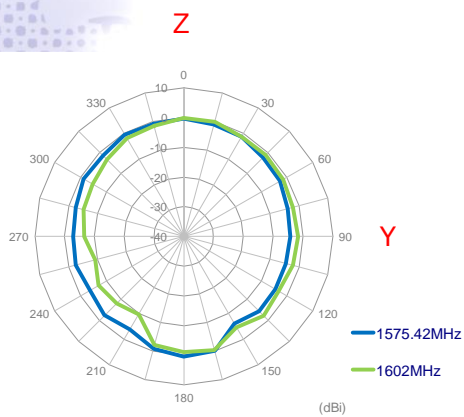

B) 3D Radiation Pattern:

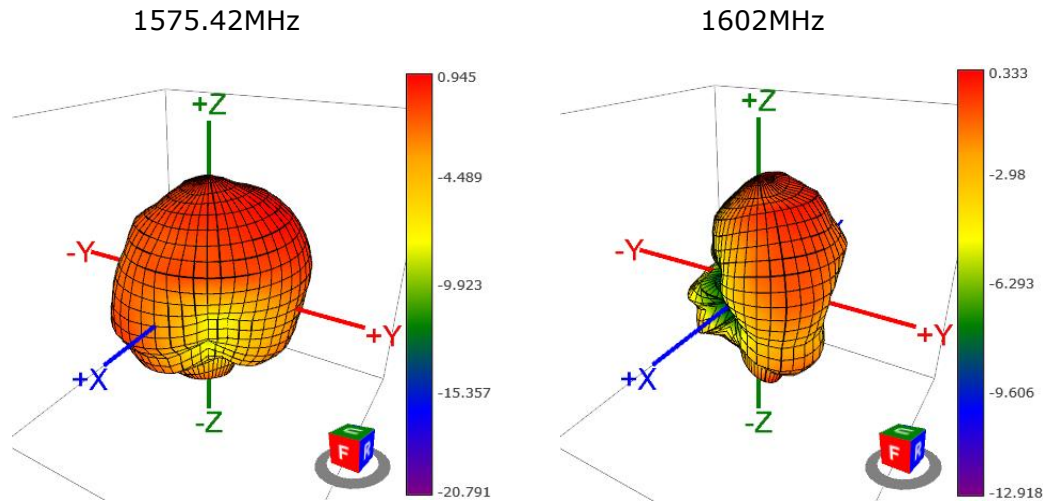

© Unictron Technologies Corp.
All specifications subject to change without notice.

V. Mechanical Drawing (Unit:mm):

- Notes:
 1. All material must be RoHS compliant.
 2. IP Code : IP67.

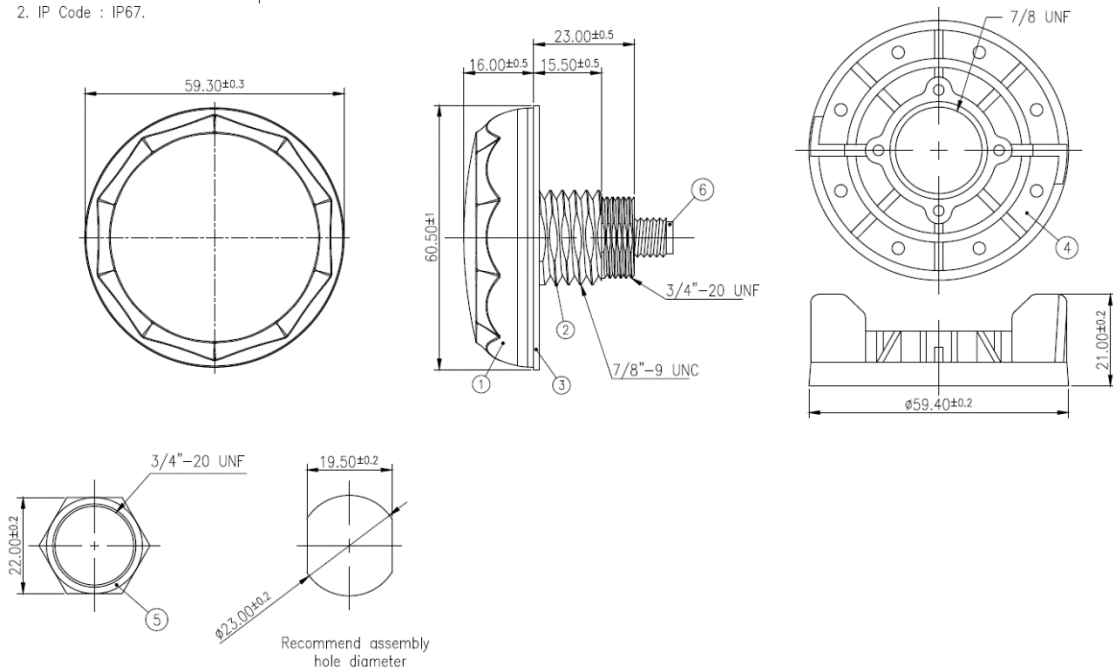

6	TNC(SBJ) Connector	Brass	Ni Plated	1
5	Nut	Brass	Ni Plated	1
4	Plastic Nut	PC+PBT	White	1
3	Gasket	Silicone	White	1
2	Bottom Base	Zinc Alloy	Ni Plated	1
1	Top Housing	PC	White	1
No	NAME	MATERIAL	FINISH	QTY